

update LTD

MBO

Perforators, Slitters and Scores



Please visit our website to explore our full list of products.
www.updateltd.com | 1-800-229-0009

Quick tips on choosing correct blades:

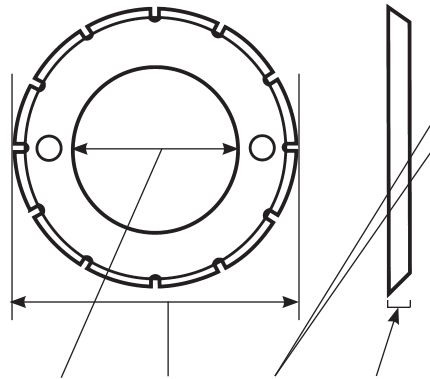

Teeth = Total number of teeth on perf
 # TPI = Number of teeth per inch
 (These are generally referred as micro perfs.)

NOTE! Lots of problems are caused by dull perfs, slitters and die blocks.

ID	OD	#Teeth	Thick
26mm	39mm	12	0.5mm
Stahl#	200-750-06-00		
Update#	SP200		

**This guide is organized first by shaft size, smallest to largest...
 Then by number of teeth, fewest to most (except micro perfs).**

All images in this guide are actual size for comparison.

“V” shaped tooth



- Maximizes the distance between each tooth in perfs with a low number of teeth such as 6, 8, 12 or 18.
- Increases the strength of the teeth in perfs with a high number of teeth such as 60, 72, 80 or more.
- Lower # of teeth (12-18) better for backbone on perfect bound books-sigs won't tear.

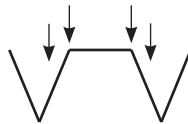

Also

If shaft is adjustable, a slightly wider perf cut can be made.

Crimping perf

- Holds sheets together temporarily.
- Used for processing zig zag folded sheets on a gather - stitcher and envelopes on a perfect binder.

Knockout (punch) perf

- Use when printed product needs perforation in the spine for adhesive binding or air relief.

Reverse Tooth

Standard



Reverse



- Assumes blades are placed on upper slitter shaft.
- Holds fold together on 16 page books.

Round Tooth

- Good for perfin multiple sheets at a time.



MBO* Perforators - 30/35mm SHAFT

30mm SHAFT

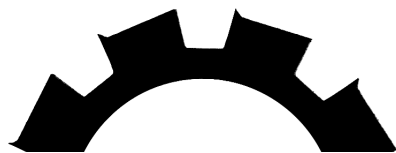

ID	OD	#Teeth	Thick
35mm	54mm	9	1.57mm
MBO#	2.0.5591.100		
Update#	KP078 - Knockout		



ID	OD	#Teeth	Thick
35mm	53mm	10	0.5mm
MBO#	2.0.5591.120		
Update#	SP278		



ID	OD	#Teeth	Thick
35mm	53mm	12	0.5mm
MBO#	2.0.5591.070		
Update#	MN888		

30mm SHAFT



ID	OD	#Teeth	Thick
35mm	53mm	15	0.5mm
MBO#	2.0.5591.030		
Update#	MN492		



ID	OD	#Teeth	Thick
	53mm	22	0.5mm
MBO#	2.0.5591.040		
Update#	SP788		



ID	OD	#Teeth	Thick
	53mm	42	0.5mm
MBO#	2.0.5591.050		
Update#	MN199		

30mm SHAFT



ID	OD	#Teeth	Thick
35mm	54mm	50TPI	0.5mm
MBO#	- N/A		
Update#	SP988 - Micro		



ID	OD	#Teeth	Thick
35mm	53mm	70	0.5mm
MBO#	2.0.5591.060		
Update#	MN592		



ID	OD	#Teeth	Thick
35mm	49mm	72TPI	0.8mm
MBO#	- N/A		
Update#	MP897		

30mm SHAFT



ID	OD	#Teeth	Thick
35mm	50mm	72TPI	0.8mm
MBO#	- N/A		
Update#	MP896		



ID	OD	#Teeth	Thick
35mm	52mm	72TPI	0.8mm
MBO#	- N/A		
Update#	MP890		



ID	OD	#Teeth	Thick
	53mm	82	0.5mm
MBO#	2.0.5591.082		
Update#	SP528		

30mm SHAFT



ID	OD	#Teeth	Thick
35mm	53mm	82	0.8mm
MBO#	- N/A		
Update#	SP059		

35mm SHAFT



ID	OD	#Teeth	Thick
40mm	62mm	5	0.5mm
MBO#	- N/A		
Update#	SP908		



ID	OD	#Teeth	Thick
40mm	62mm	6"V"	0.5mm
MBO#	- N/A		
Update#	SP720		

*MBO is a registered trademark of MBO

MBO* Perforators - 35mm SHAFT

35mm SHAFT



ID	OD	#Teeth	Thick
40mm	61.5mm	8	0.5mm
MBO#	50210040		
Update#	SP538		



ID	OD	#Teeth	Thick
40mm	61.5mm	8	0.5mm
MBO#	- N/A		
Update#	SP228		



ID	OD	#Teeth	Thick
40mm	61.5mm	8V	0.5mm
MBO#	- N/A		
Update#	SP520		

35mm SHAFT



ID	OD	#Teeth	Thick
40mm	62mm	10	0.5mm
MBO#	50210450		
Update#	SP502		



ID	OD	#Teeth	Thick
40mm	62mm	10	0.5mm
MBO#	60210260		
Update#	KP378 - Knockout		



ID	OD	#Teeth	Thick
40mm	61.5mm	12	0.5mm
MBO#	50210050		
Update#	MS292		

35mm SHAFT



ID	OD	#Teeth	Thick
40mm	61.5mm	12V	0.5mm
MBO#	50210410		
Update#	SP807		



ID	OD	#Teeth	Thick
40mm	62mm	12	0.5mm
MBO#	-NA		
Update#	SP650		



ID	OD	#Teeth	Thick
40mm	61.5mm	12	0.5mm
MBO#	- N/A		
Update#	SP808 - Reverse		

35mm SHAFT



ID	OD	#Teeth	Thick
40mm	62mm	12	1.2mm
MBO#	60210280		
Update#	KP718 - Knockout		



ID	OD	#Teeth	Thick
40mm	64mm	12	0.5mm
MBO#	- N/A		
Update#	MS296		



ID	OD	#Teeth	Thick
40mm	64mm	12	0.9mm
MBO#	60210300		
Update#	KP418 - Knockout		

35mm SHAFT



ID	OD	#Teeth	Thick
40mm	64mm	12	1.2mm
MBO#	- N/A		
Update#	KP997 - Knockout		



ID	OD	#Teeth	Thick
40mm	64mm	12	1.2mm
MBO#	- N/A		
Update#	KP518 - Knockout		



ID	OD	#Teeth	Thick
40mm	61.5mm	14	0.5mm
MBO#	50210460		
Update#	SP298		

*MBO is a registered trademark of MBO

MBO* Perforators - 35mm SHAFT

35mm SHAFT

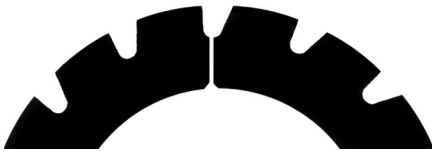

ID	OD	#Teeth	Thick
40mm	61.5mm	15	0.5mm
MBO#	50211160		
Update#	SP289		



ID	OD	#Teeth	Thick
40mm	61.5mm	15	0.5mm
MBO#	- N/A		
Update#	SP802		



ID	OD	#Teeth	Thick
40mm	61.5mm	16	0.5mm
MBO#	50210970		
Update#	SP600		

35mm SHAFT



ID	OD	#Teeth	Thick
40mm	62mm	16	0.5mm
MBO#	50211630		
Update#	SP188 - Reverse		



ID	OD	#Teeth	Thick
40mm	60mm	18	0.5mm
MBO#	50210390		
Update#	SP488		



ID	OD	#Teeth	Thick
40mm	61.5mm	18	0.5mm
MBO#	50210060		
Update#	MS293		

35mm SHAFT



ID	OD	#Teeth	Thick
40mm	61.5mm	18	0.5mm
MBO#	50210420		
Update#	SP288		



ID	OD	#Teeth	Thick
40mm	61.5mm	18	0.5mm
MBO#	5.0.5591.060		
Update#	SP640spec		



ID	OD	#Teeth	Thick
40mm	62mm	18	0.5mm
MBO#	- N/A		
Update#	SP590 - Reverse		

35mm SHAFT



ID	OD	#Teeth	Thick
40mm	64mm	18	0.5mm
MBO#	- N/A		
Update#	MS297		



ID	OD	#Teeth	Thick
40mm	62mm	18V	0.5mm
MBO#	- N/A		
Update#	SP928		



ID	OD	#Teeth	Thick
40mm	60mm	28	0.5mm
MBO#	50210210		
Update#	SP588		

35mm SHAFT



ID	OD	#Teeth	Thick
40mm	61.5mm	28	0.5mm
MBO#	50210070		
Update#	MN820		



ID	OD	#Teeth	Thick
40mm	62mm	30	0.5mm
MBO#	- N/A		
Update#	MS294		



ID	OD	#Teeth	Thick
40mm	64mm	30	0.5mm
MBO#	- N/A		
Update#	SP060		

*MBO is a registered trademark of MBO

MBO* Perforators - 35mm SHAFT

35mm SHAFT



ID	OD	#Teeth	Thick
40mm	62mm	30V	0.5mm
MBO#	- N/A		
Update#	SP321		



ID	OD	#Teeth	Thick
40mm	61.5mm	32V	0.5mm
MBO#	- N/A		
Update#	SP392		



ID	OD	#Teeth	Thick
40mm	60mm	36	0.5mm
MBO#	50210720		
Update#	SP458		

35mm SHAFT



ID	OD	#Teeth	Thick
40mm	62mm	40	0.5mm
MBO#	- N/A		
Update#	SP468		



ID	OD	#Teeth	Thick
40mm	61.5mm	45	0.5mm
MBO#	- N/A		
Update#	SP408		



ID	OD	#Teeth	Thick
40mm	60mm	48	0.5mm
MBO#	50210240		
Update#	SP333		

35mm SHAFT

Not Pictured



ID	OD	#Teeth	Thick
40mm	60mm	12	0.5mm
MBO#	- N/A		
Update#	SP111		



ID	OD	#Teeth	Thick
40mm	61.5mm	60V	0.5mm
MBO#	- N/A		
Update#	MS897		

35mm SHAFT



ID	OD	#Teeth	Thick
40mm	62mm	60	0.5mm
MBO#	- N/A		
Update#	MS295		



ID	OD	#Teeth	Thick
40mm	62mm	72TPI	0.5mm
MBO#	- N/A		
Update#	SP738		

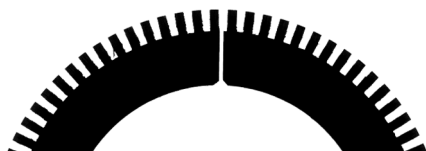

ID	OD	#Teeth	Thick
40mm	60mm	80	0.5mm
MBO#	50210230		
Update#	SP999		

35mm SHAFT



ID	OD	#Teeth	Thick
40mm	62mm	80	0.5mm
MBO#	- N/A		
Update#	SP560		



ID	OD	#Teeth	Thick
40mm	59mm	80V	0.5mm
MBO#	- N/A		
Update#	SP888		



ID	OD	#Teeth	Thick
40mm	60mm	80V	0.5mm
MBO#	- N/A		
Update#	SP999spec		

*MBO is a registered trademark of MBO

MBO* Perforators - 35/40/65mm SHAFT

35mm SHAFT



ID	OD	#Teeth	Thick
40mm	60mm	100	0.5mm
MBO#	- N/A		
Update#	SP338		



ID	OD	#Teeth	Thick
40mm	61.5mm	100	0.5mm
MBO#	- N/A		
Update#	SP777		



ID	OD	#Teeth	Thick
40mm	60mm	124	0.5mm
MBO#	- N/A		
Update#	SP608		

40mm SHAFT

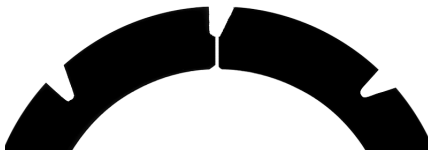

ID	OD	#Teeth	Thick
45mm	61.5mm	8	0.5mm
MBO#	- N/A		
Update#	SP703		

Not Pictured

ID	OD	#Teeth	Thick
45mm	61.5mm	10	0.5mm
MBO#	50210190		
Update#	SP704		



ID	OD	#Teeth	Thick
45mm	62mm	18	0.5mm
MBO#	50210190		
Update#	SP628		

40mm SHAFT

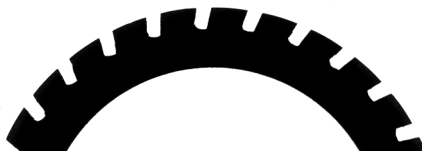

ID	OD	#Teeth	Thick
45mm	61mm	28	0.5mm
MBO#	50210370		
Update#	SP850		



ID	OD	#Teeth	Thick
45mm	60mm	48	0.5mm
MBO#	50210380		
Update#	SP728		

65mm SHAFT

Not Pictured

ID	OD	#Teeth	Thick
70mm	100mm	9	0.8mm
MBO#	- N/A		
Update#	SP088		

65mm SHAFT



ID	OD	#Teeth	Thick
70mm	100mm	13	0.5mm
MBO#	- N/A		
Update#	SP778		

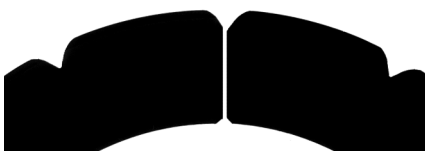

ID	OD	#Teeth	Thick
70mm	100mm	13	0.5mm
MBO#	- N/A		
Update#	SP878		

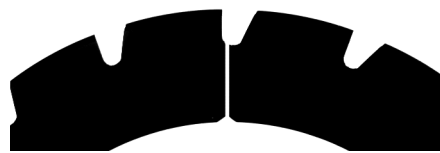

ID	OD	#Teeth	Thick
70mm	100mm	18	0.5mm
MBO#	50210341		
Update#	SP651		

65mm SHAFT



ID	OD	#Teeth	Thick
70mm	100mm	24	0.5mm
MBO#	50211130		
Update#	SP678		

Not Pictured

ID	OD	#Teeth	Thick
70mm	100mm	26	0.5mm
MBO#	50210351		
Update#	SP678		

Not Pictured

ID	OD	#Teeth	Thick
70mm	100mm	26	1.0mm
MBO#	50211300		
Update#	SP978		

*MBO is a registered trademark of MBO

MBO* Slitters & Scores - 30/35mm SHAFT

30mm SHAFT



ID	OD	#Teeth	Thick
35mm	50.8mm	-	0.8mm
MBO#	2.0.5591.080		
Update#	SS163 - Score		



ID	OD	#Teeth	Thick
35mm	52mm	-	0.8mm
MBO#	2.0.5591.020		
Update#	MS537 - Score		

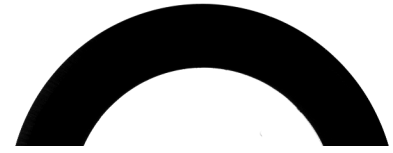

ID	OD	#Teeth	Thick
35mm	52mm	-	0.8mm
MBO#	- N/A		
Update#	SS643 - Slitter		

30mm SHAFT



ID	OD	#Teeth	Thick
35mm	53.5mm	-	0.5mm
MBO#	- N/A		
Update#	SS853 - Slitter		

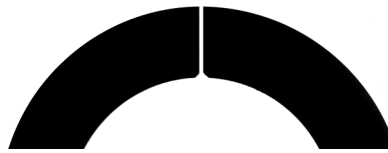

ID	OD	#Teeth	Thick
35mm	54mm	-	0.5mm
MBO#	- N/A		
Update#	SS753 - Slitter		



ID	OD	#Teeth	Thick
35mm	54mm	-	0.8mm
MBO#	2.0.5591.010		
Update#	MN153 - Slitter		

30mm SHAFT



ID	OD	#Teeth	Thick
35mm	55mm	-	0.8mm
MBO#	- N/A		
Update#	MN253 - Slitter		



ID	OD	#Teeth	Thick
40mm	58.8mm	-	0.8mm
MBO#	50210550		
Update#	SS080 - Score		



ID	OD	#Teeth	Thick
40mm	59mm	-	0.8mm
MBO#	50210550		
Update#	SS083 - Score		

35mm SHAFT



ID	OD	#Teeth	Thick
40mm	59.5mm	-	0.8mm
MBO#	50210020		
Update#	SS233 - Score		

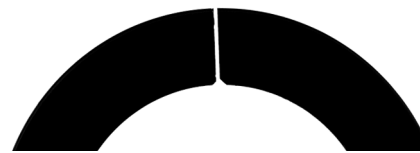

ID	OD	#Teeth	Thick
40mm	60mm	-	0.8mm
MBO#	50210220		
Update#	SS283 - Score		



ID	OD	#Teeth	Thick
40mm	60mm	-	1.0mm
MBO#	- N/A		
Update#	SS555 - Slitter		

35mm SHAFT



ID	OD	#Teeth	Thick
	60mm	-	1.5mm
MBO#	- N/A		
Update#	SS973 - Score		

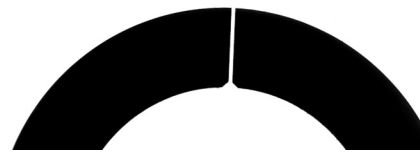

ID	OD	#Teeth	Thick
40mm	61mm	-	0.8mm
MBO#	- N/A		
Update#	MN100 - Score		



ID	OD	#Teeth	Thick
40mm	61.5mm	-	0.5mm
MBO#	50210260		
Update#	MN453 - Slitter		

*MBO is a registered trademark of MBO

MBO* Slitters & Scores - 35/40/65mm SHAFT

35mm SHAFT



ID	OD	#Teeth	Thick
40mm	61.5mm	-	1.0mm
MBO#	50210760		
Update#	MN353 - Slitter		



ID	OD	#Teeth	Thick
40mm	61.5mm	-	1.5mm
MBO#	50210860		
Update#	SS563 - Score		



ID	OD	#Teeth	Thick
40mm	62mm	-	0.5mm
MBO#	50210030		
Update#	MN400 - Slitter		

35mm SHAFT



ID	OD	#Teeth	Thick
40mm	62mm	-	2.0mm
MBO#	5021050		
Update#	SS005 - Slitter		



ID	OD	#Teeth	Thick
40mm	62mm	-	3.0mm
MBO#	- N/A		
Update#	SS900 - Slitter		

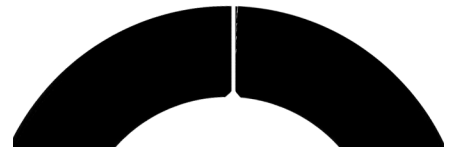

ID	OD	#Teeth	Thick
40mm	64mm	-	0.5mm
MBO#	50210480		
Update#	MN911- Slitter		

35mm SHAFT



ID	OD	#Teeth	Thick
40mm	64mm	-	2.0mm
MBO#	- N/A		
Update#	SS006 - Slitter		

40mm SHAFT



ID	OD	#Teeth	Thick
45mm	61.5mm	-	0.5mm
MBO#	50210150		
Update#	SS051 - Slitter		



ID	OD	#Teeth	Thick
45mm	61.5mm	-	0.5mm
MBO#	- NA		
Update#	SS052 - Slitter		

40mm SHAFT



ID	OD	#Teeth	Thick
45mm	61.5mm	-	0.5mm
MBO#	50210780		
Update#	SS087 - Slitter		

65mm SHAFT

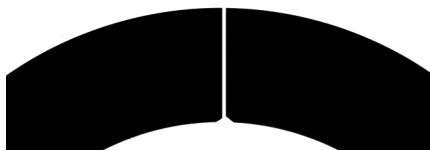

ID	OD	#Teeth	Thick
70mm	100mm	-	0.5mm
MBO#	50210331		
Update#	SS133 - Slitter		